

FUNDAMENTALS OF ENERGY DETERMINATION

David Hailey, Ph.D.

Cosa Instrument Corp
7125 North Loop East
Houston, TX 77029

Abstract

This paper presents fundamental information necessary to understand and appreciate the concept of total gas energy in a natural gas pipeline. That is, to be able to converse with peers within the natural gas industry and understand basic concepts and terminology.

Discussed is the historical transition from volumetric measurement to total gas energy including some of the basic terminology, physics, measurement, as well as the reasons for changes in methodologies. Included is industry acceptance of new concepts and regulations involving custody transfer as well as the instrumentation and systems involved in traditional and newer, more progressive forms of gas measurement.

Where Does Natural Gas Come From?

Millions of years ago, the remains of plants and animals decayed and built up in thick layers. This decayed matter from plants and animals is called organic material -- it was once alive. Over time, the mud and soil changed to rock, covered the organic material, and trapped it beneath the rock. Pressure and heat changed some of this organic material into coal, some into oil (petroleum), and some into natural gas -- tiny bubbles of odorless gas. The main ingredient in natural gas is methane, a gas (or compound) composed of one carbon atom and four hydrogen atoms.

Figure 1 shows an Ocean bed at 300 to 400 million years ago. Tiny sea plants and animals died and were buried on the ocean floor. Over time, they were covered by layers of sand and silt.

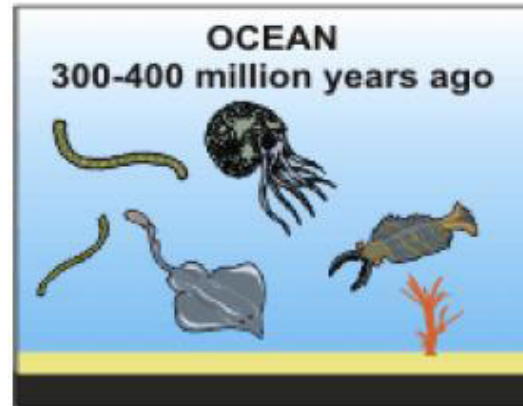

Tiny sea plants and animals died and were buried on the ocean floor. Over time, they were covered by layers of silt and sand.

Figure 1

Figure 2 illustrates the Ocean at 50 to 100 million years ago. Over millions of years, the remains were buried deeper and deeper. The enormous heat and pressure turned them into oil and gas.

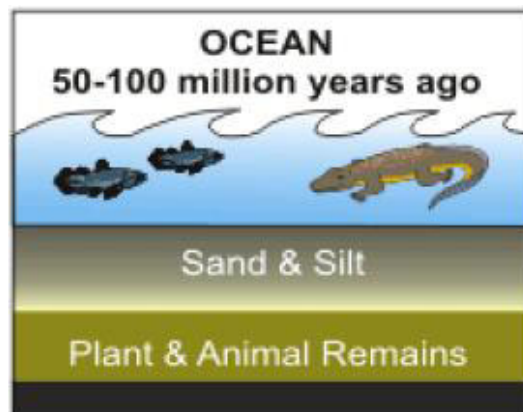

Over millions of years, the remains were buried deeper and deeper. The enormous heat and pressure turned them into oil and gas.

Figure 2

Figure 3 depicts Oil & Gas Deposits. Today, we drill down through layers of sand, silt, and rock

to reach the rock formations that contain oil and gas deposits

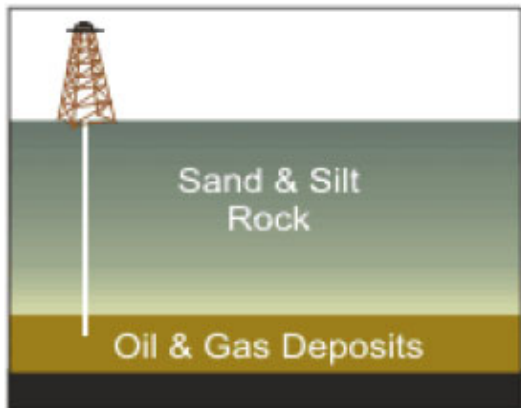

Today, we drill down through layers of sand, silt, and rock to reach the rock formations that contain oil and gas deposits.

Figure 3

How Is Natural Gas Stored And Delivered?

Figure 4 shows how Natural gas is moved by pipelines from the producing fields to consumers. Since natural gas demand is greater in the winter, gas is stored along the way in large underground storage systems, such as old oil and gas wells or caverns formed in old salt beds. The gas remains there until it is added back into the pipeline when people begin to use more gas, such as in the winter to heat homes.

When chilled to very cold temperatures, approximately -260 degrees Fahrenheit, natural gas changes into a liquid and can be stored in this form. Liquefied natural gas (LNG) can be loaded onto tankers (large ships with several domed tanks) and moved across the ocean to deliver gas to other countries. Once in this form, it takes up only 1/600th of the space that it would in its gaseous state. When this LNG is received in the United States, it can be shipped by truck to be held in large chilled tanks close to users or turned back into gas to add to pipelines.

When the gas gets to the communities where it will be used (usually through large pipelines), the gas is measured as it flows into smaller pipelines called "MAINS". Very small lines, called "SERVICES", connect to the mains and go directly to homes or buildings where it will be used. (Source EIA)

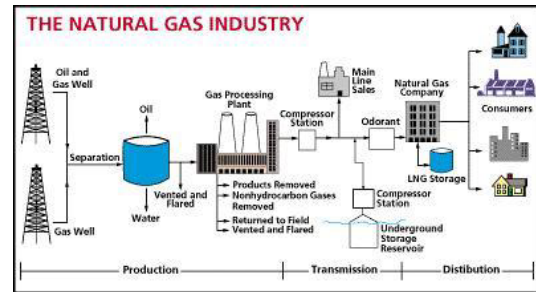

Figure 4

Gas Energy vs. Volume

It has been the traditional practice for gas companies to conduct business on a cost per volume basis, (volumetric custody transfer). Typically in the United States, this has been done on a cost per standard cubic foot of natural gas. This practice began to change, however, when Congress passed the Natural Gas Policy Act of 1978 that came as a result of price differentials between state and federally regulated natural gas. The Act sought to restore consumer confidence and instill a sense of fairness in the gas system. One of its provisions specified that natural gas be bought and sold on the basis of energy content. Another milestone was FERC Order 436 enacted 1987 which effectively opened interstate pipelines for use as transportation conduits for companies independently buying and selling natural gas. In many cases, interstate pipelines had restricted access to anyone other than their own organization. Under revised laws and regulations, end users were free to purchase gas on a commodity basis and were encouraged to bargain for best pricing that would directly benefit end use consumers. The cost benefits were initially impressive, but not to all customers. Compared to previous experience, it soon became apparent that changes in gas quality resulted in increased consumption at some sites while others metered less. The Natural Gas Wellhead Decontrol Act of 1989 was another step in deregulation of natural gas pricing. In 1992 FERC Order 636 is meant to give all natural gas sellers equal footing in moving natural gas from the wellhead to the end-user or local distribution company. This allowed for the unbundling of transportation, storage, and marketing; so the customer now chooses the most efficient method of obtaining gas.

Gas flow is effected by factors such as temperature, pressure, composition, and physical dimensions of the primary element and

supporting meter run. As gas pressure increases, more gas molecules can be essentially packed within a given space - a pipeline. Likewise, as gas temperature decreases, more gas molecules can be accommodated. In general, flow has an inverse relationship to heating value, that is, for higher quality gas, less volume is required to support a given load than is required by a lower quality gas.

There are industry procedures, reports and standards, (e.g. AGA-3, AGA-7, AGA-9, ASTM D4891, GPA-2172, etc.) which account for the impact that these various factors have on volumetric and energy flows.

Gas energy is volumetric flow at base (reference) conditions multiplied by the heating value (overall quality) of the gas. The buying and selling of natural gas can only be truly effective and fair if total energy is the basis of measurement.

Common Terminology

A common problem when discussing energy flow is the difference in each persons understanding of terminology, reference conditions and the standards in place. It is important to agree on the terms that define the pieces of the energy puzzle. Terminology, definitions, and reference conditions must be understood before any meaningful discussion can take place.

Gas Energy:

Gas volume or flow adjusted for gas quality, that is, volume at base conditions multiplied times heating value. Total gas energy is the capacity for doing the work natural gas is targeted for. The quality of the gas has an inverse relationship to volumetric flow. The higher the gas quality the lower the flow requirements for a defined load and visa-versa.

Base Conditions:

Base, standard or normal conditions are the reference points for measurement. These define the reference temperature, (usually 60⁰) Fahrenheit and the reference pressure. The most common pressure base used is 14.73 psia but other pressures may be encountered such as 14.60, 14.65 or 14.70 psia. Which ever figure is used it must agree with other gases under comparison.

Standard Cubic Foot (SCF):

The quantity or volume of gas occupying a cubic foot of space at a specified pressure and temperature.

Gross Heating Value:

The heating value (Btu) produced by combustion at constant pressure with the following conditions:

- (a) a volume of one cubic foot.
- (b) 60⁰ Fahrenheit.
- (c) reference base pressure.
- (d) with air and gas having the same temperature and pressure.
- (e) recovered heat from the water vapor formed by combustion.

Gross heating value is the most commonly used condition/definition of heating value in the natural gas industry, it is also referred to as the superior heating value.

Net Heating Value:

The heating value produced under conditions similar to gross heating value conditions excepting the amount of heat potentially recovered from the water vapor produced at combustion. Net heating value is always less than gross heating values. It is sometimes referred to as the inferior heating value.

Saturated Heating Value:

The heating value of a standard cubic foot of gas saturated with water vapor. The amount of water present per given volume is defined by contract.

Dry Heating Value:

The heating value of a standard cubic foot of gas without water vapor.

The saturated heating value of a standard cubic foot of gas is always less than the dry heating value per SCF because of the displacement of hydrocarbon molecules by water molecules. For example, the saturated value of methane (CH₄) is 997 BTU at 14.73 psia and 60⁰ F. but the dry value of the same gas under the same conditions is 1014.3 BTU.

Relative Density:

The ratio of the density a gas to the density of dry air under the same pressure and temperature conditions, (it sometimes referred to as specific gravity).

Wobbe Index:

The ratio of the gross heating value of a gas to the square root of the relative density of the gas, ($WI = H_v / \sqrt{RD}$). Wobbe index is a measure of the amount of energy delivered to a burner via an injector (orifice). The energy input is a linear function of Wobbe index. Two gases differing in composition but having the same Wobbe index will deliver the same amount of energy for any given injector/orifice under the same injector pressure.

Value Comparisons

Today's energy reports are commonly made by volume with energy corrector factors, BTU per standard cubic foot or in dekatherms (1,000 scf of 1,000 Btu of gas). Energy accounting is commonly referred to as "therm billing" as opposed to volume billing.

There are many factors involved with total energy measurement. Some are fixed such as pipe sizing or whether a differential or pulse output primary element is used. Others may be variable such as static and differential pressures, temperature, or gas composition. These factors are used in combination to arrive at the standard base conditions which is the reference for custody transfer.

The most common base conditions are 60⁰ F. and 14.73 PSIA but it is possible that your associate may be using different conditions which can lead to misunderstandings. For example, if methane (CH₄) is valued at 1014.3 BTU (dry) at 60⁰ F. and 14.73 PSIA, the same gas will convert to 1006.8 at 60⁰ and 14.65 PSIA. The higher the base pressure, the higher the Btu.

Often conflicts and miscommunications arise simply because the parties are not comparing gases at the same base conditions, proverbially not comparing apples with apples!

Flow Measurement

There are two major methods for measuring gas flow, inferential and positive displacement. Although there are many types of meters falling into each category, we are primarily concerned with five, orifice plates, turbine meters, ultrasonic, diaphragm and rotary meters.

Orifice Meters:

An orifice plate is a restrictive element in the pipeline with a precise hole in its center, Figure 5.

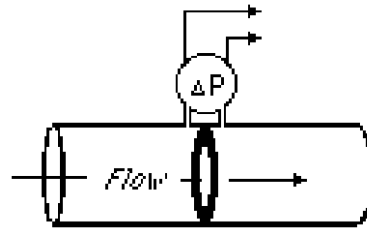

Figure 5

An orifice plate essentially functions as a meter from which a differential pressure signal is developed as a function of gas flowing through the orifice bore. Flow is proportional to the square of the pressure differential (DP or ΔP) between an upstream tap, across the orifice plate to the downstream tap, hence the term, "square law devices". This is an inferential signal developed under flowing conditions and does not take into consideration the various factors necessary to produce an accurate representative number. Correct flow at pipeline conditions or flow at base reference conditions is derived from the rules, conditions and equations set forth in AGA Report Number 3.

Also known as ANSI/API 2530 and GPA 8185, AGA-3 describes and defines the mathematics, equipment and procedures involved with the measurement of natural gas flow using flange tap and pipe tap orifice meters. It provides standards of construction and installation of orifice plates, meter tubes, and associated fittings as well as computations providing basic factors to adjust for the primary element expansion, flowing fluid density, flowing fluid expansion, Reynolds number, temperature, pressure, relative density and compressibility. That is, to correct for all the variations effecting measurement and to arrive at a true and accurate measurement relative to flow at pipeline conditions and or flow at base reference conditions.

Turbine Meters:

Turbine meters are velocity measuring (inferential) devices whereby a rotor ideally spins at a speed proportional to the gas flow rate - an analogy is a wind vane. However, rotational speed is a function of passageway size and shape and rotor design. It is also dependent upon the load imposed due to mechanical friction, fluid drag, external loading and gas density. Rotor revolutions are counted mechanically or electrically, Figure 6.

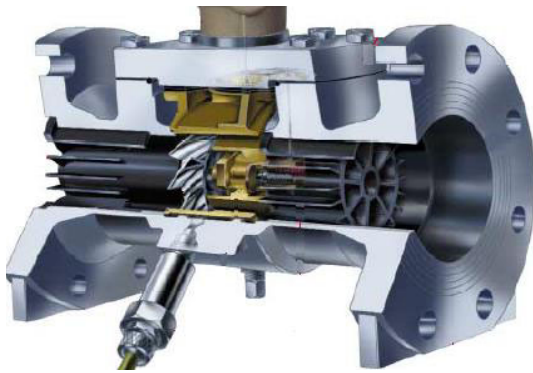

Figure 6

Counts or pulses are converted to a continuously totalized volumetric registration but since this flow is measured at pipeline conditions, it must be corrected to specified base conditions for true reference and billing purposes. Rules, conditions and corrective factors are detailed in AGA Report Number 7.

AGA-7 defines installation, calibration, operation and calculation methods applied to axial-flow-type turbine meters measuring volumetric and mass flow.

In Europe, turbine meters are now the preferred metering method for custody transfer.

Ultrasonic Flow Meters:

Ultrasonic flow meters are available in two fundamental design categories, doppler and transit time or time of flight. The preferred version used in natural gas applications is the latter, time of flight approach. They operate by bouncing a high frequency energy pulse against the piping sidewall to a second receiver or transducer, Figure 7. By subtracting the time of flight of alternating pulse transmissions downstream, then upstream, a transit time differential is calculated. Once the meter has been properly calibrated, this difference in time is proportional to the gas flow rate,

$$Q = \Delta T = t_a - t_b.$$

As with all meters, pressure, temperature, gas composition and meter factors must be accounted for to correct actual cubic feet flow to flow at base conditions.

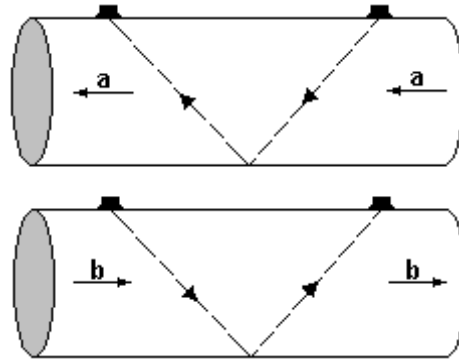

Figure 7

Ultrasonic flow meters subscribe to Report AGA-9 for basic standards of operation and installation and AGA-10 for Speed of sound calculation (not finalized at this writing).

Diaphragm Meters:

A diaphragm meter is a positive displacement device whereby the flexing of an internal diaphragm indicates a specific volume of gas that has been transferred. This displacement action is actuated by the differential pressure developed by gas demand on the downstream side of the meter. Diaphragm meters are in wide use in the low pressure gas distribution business although high pressure meters are also on use. Figure 8.



Figure 8

Rotary Piston Meters:

Commonly known as rotary meters these positive displacement devices feature two counter rotating “figure 8” or lobed impellers. These impellers, or rotors, move as a function of the force of flowing gas and are unaffected by gas density, turbulence and pulsation in the line. The rotor lobes form a defined space between the impeller and the meter wall, hence the term, “positive displacement meter”. For each complete internal rotation of the meter four defined volumes of gas are displaced. By

knowing the volume of these spaces very precise measurements can be accomplished. Figure 9.

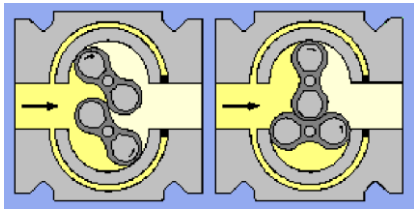

Figure 9

Gas Quality

Heating value generally notes quality of natural gas. In the USA, our standard of measurement is in British Thermal Units or "Btu". There are two general methods for determining BTU, direct and indirect. Two approaches representative of the methods are gas chromatography and calorimetry. Both have advantages and disadvantages as compared to one another.

Gas Chromatography:

Indirect measurement (calculated) is most commonly represented by gas chromatographs. These instruments run the full range accuracy, repeatability and reproducibility. At one end are laboratory chromatographs which are quite sophisticated, require close support but provide extensive information on a detailed basis. At the other extreme are process instruments that typically operate faster and do not require as much operator attention. However, they lack the detailed analysis produced by the more complex laboratory instruments. The number of gas components to be identified typically determines the level of sophistication.

Gas chromatographs consist of three main sections, the sample conditioning system, the oven and the controller. Each has its own identity and must be carefully integrated into the final instrument designed to best target the application. Figure 10.

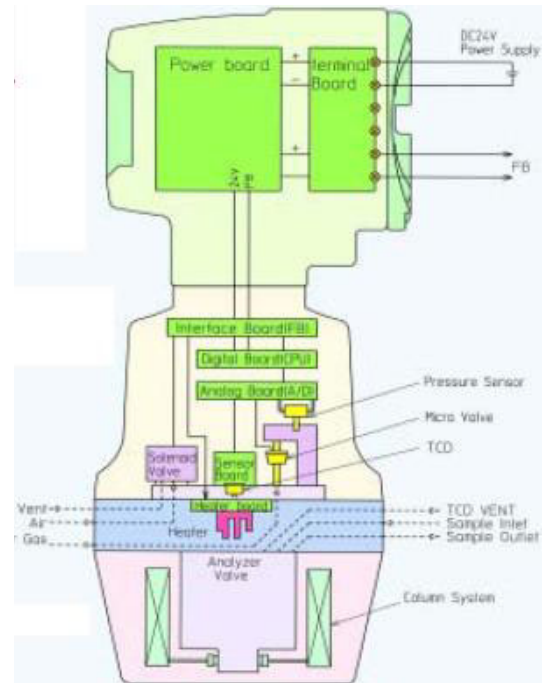

Figure 10

A precise amount of sample gas is injected into a flowing stream of carrier gas which is usually ultra high purity helium. The mixture then flows into and through a column packed with a coated granular material unique to the properties of the sample gas. There are literally hundreds of different columns available which requires the operator to specify the correct column for the particular application. As gas travels through the column and around the coated material, its components begin to separate as a function of time and temperature. Gas flows out and by a detector which measures each identified constituent or group of constituents. A graphic representation called a chromatogram is produced as a response to the detector output. Figure 11.

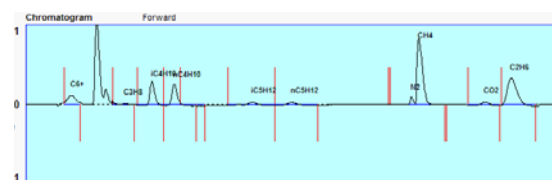

Figure 11

The chromatogram is raw data listing of component peak numbers, retention time, peak area and height. A computer uses this information to calculate and produce a report detailing the mole percent of components, heating value, relative density and compressibility factor.

Calorimetry:

Known as direct measurement because of its method of determining heating value, combustion calorimetry is represented by two main groups of instruments, heat transfer and stoichiometric combustion.

The recording calorimeter known as the Cutler Hammer was the primary direct measurement standard dating from the 1930's. This instrument uses a fixed ratio to mix gas and air resulting in optimum combustion. Heat of combustion is transferred to an exchanger that in turn transfers heat to a stream of air. Air temperature is recorded before and after passing around the exchanger. The difference of temperatures before and after passing around the exchanger is proportional to heating value. Figure 12.

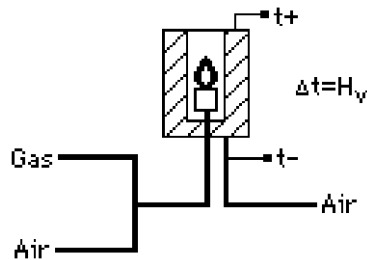

Figure 12

The second direct method utilizes principles of the residual oxygen measurement. This is a flameless technology that measures the excess oxygen from a continuous stream of sample gas which is oxidized in a catalytic converter. The sample gas and air mixture from the fuels conditioning system is catalytically combusted in an oven whose temperature is set to approximately 812°C and by a thermocouple and PID algorithm programmed in the microcontroller. Figure 13.

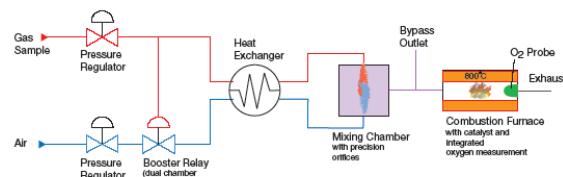

Figure 13

The air to fuels ratio is calculated to select the AIR/GAS orifices in the mixing chamber so that there is always an excess of oxygen in the exhaust gas. The measurement of excess oxygen provides a direct measurement of the Combustion Air Requirement Index (CARI) of the fuel, which can then be mathematically

correlated to the Wobbe Index. Differences between the CARI and Wobbe Index values are cancelled out by the use of calibration gases thus giving this technique the ability to report Wobbe Index values along with CARI. With the Specific Gravity Cell, Btu is reported as well. Figure 14.

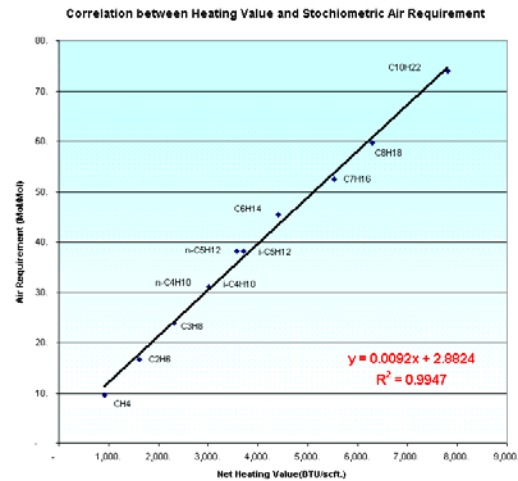

Figure 14

SCADA & DCS

For pipeline control systems a real-time overview of the complete status of the pipeline is important. Figure 15. Since the metering sites are often unmanned, control of the metering sites and the block valve operation is often centralized in the gas control center. Traditionally, pipeline SCADA (supervisory control and data acquisition) systems are used in conjunction with telemetry over telephone lines, cellular, radio or satellite. Connectivity over fiber optic cables, are becoming more cost effective, local area networks and intranet technologies are becoming more popular.

As typical SCADA systems consists of a central host or master MTU (master terminal unit), connected to several RTU's (remote station units) for data gathering and control. These systems have open-loop control and utilize mostly long distance communications, but some parts of these systems utilize closed-loop controls and will use short distance communications for local control and data gathering.

A DCS (distributed control system) is somewhat similar to a SCADA system in functionality, but the data gathering and control functions are usually co-located. Communication connections

are made generally via a LAN (local area network) because of its reliability and high speed. A DCS system usually employs a large number of local closed loop controls.

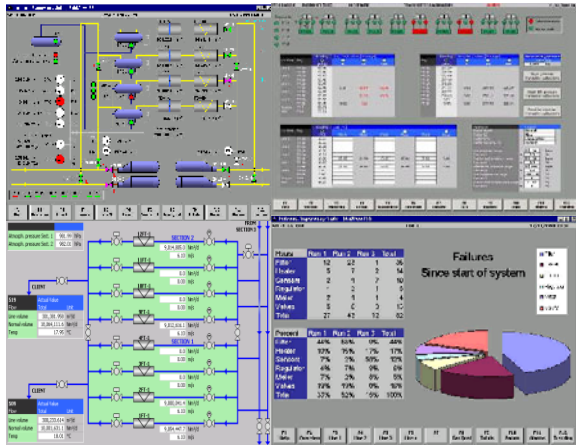

Figure 15

Conclusion

Because of the dynamic nature of today's natural gas quality, total natural gas energy is paramount to accurate measurement and fair custody transfer. There are a variety of hardware and software systems and devices to accomplish accurate measurement. As long as the various parties agree to what constitutes accurate measurement disputes will be minimized. It is vital that all parties agree on the technical terms, language and base references of total energy measurement.

Work Cited:
Energy Information Administration
(www.eia.doe.gov)

END